

DLP Projector

LV-WX320/LV-X320/LV-WX310ST/LV-X310ST

■ Outline of product

This device is a series of DLP portable projectors each featuring a brightness of 3200 lumens* in a compact body that weighs only 2.5kg*. User can select a projector from four different types depending on the image resolution and usage applications.

*Short Throw model:3100 lumen 2.8kg

■ Product specifications (Specifications and appearance may change without prior notice for reasons such as manufacturing and changes of components.)

Used power	AC100 - 240 V 50Hz/60Hz
Consumed power	Standard: 330W / Quiet: 275W, Standby: 3.0W / Standby (LAN-off): 0.5W
Picture element	<LV-WX320/LV-WX310ST>0.65-type DMD device (aspect ratio 16:10) Number of pixels: 1024000 pixels (1280 dots x 800 dots, WXGA) <LV-X320/LV-X310ST>0.55-type DMD device (aspect ratio 4:3) Number of pixels: 786432 pixels (1024 dots x 768 dots, XGA)
Projection lens	Varifocal lens <LV- WX320 >F value: 2.56 – 2.8, Focus distance: 21.0 – 23.1mm, 100-inch projection distance: 3.34 – 3.66m, Zoom ratio: 1.1 x (manual), Focus: manual <LV-X320/LV-X310ST > F value: 2.56 – 2.8, Focus distance: 21.0 – 23.1mm, 100-inch projection distance: 3.98 – 4.37m, Zoom ratio: 1.1 x (manual), Focus: manual <LV-WX310ST> F value: 2.60, Focus distance: 6.9mm, 100-inch projection distance: 1.06m, Zoom ratio: 1.1 x (manual), Focus: manual <LV-WX310ST> F value: 2.60, Focus distance: 6.9mm, 100-inch projection distance: 1.24m, Zoom ratio: 1.1 x (manual), Focus: manual
Light source lamp	Ultra-high pressure mercury lamp (Output Standard : 210W/Quiet:170W; Quiet figure is a calculated value thus not guaranteed)
Projected image size	<LV-WX320>W: 60-inch – 180-inch (2-6 m)/T: 60-inch – 180-inch (2.2–6.6 m) <LV-X320><LV-S300> W: 60-inch – 180-inch (2.38 – 7.15m)/T: 60-inch – 180-inch (2.62 – 7.87 m) <LV-WX310ST>W: 70-inch – 120-inch (0.74-1.26m) <LV-X310ST>W: 60-inch – 120-inch (0.74-1.48m)
Light output*	<LV-WX320/LV-X320>Standard: 3200lm/Quiet: 2550lm<LV-WX310ST/LV-X310ST>Standard: 3100lm/Quiet: 2450lm (Quiet figure is a calculated value thus not guaranteed)
Peripheral contrast*	<LV-WX320>75%; <LV-X320>80% <LV-WX310ST> 70% <LV-X310ST>80%
Contrast ratio*	10,000:1(Fully white: fully black, presentation mode, Analog PC input)
Input signal resolution	UXGA to VGA
Corresponding scanning frequency	See List of supported signals
Lens shift	<LV-WX320> 50%, fixed; <LV-X320>60%, fixed<LV-WX310ST>55%,fixed、<LV-X310ST>65%,fixed
Keystone correction range	VH ±30°
Projection method	Floor-mounted front Analog PC input: UXGA/SXGA+/WXGA+/FWXGA/WXGA/SXGA/XGA/SVGA/VGA/MAC
Video signal	HDMI input:- When connecting with a PC: UXGA/SXGA+/ WXGA+/FWXGA/WXGA/SXGA/XGA/SVGA/VGA When connecting with an AV equipment: 1080p/1080i/720p/576p/480p Component video input: 1080p/1080i/720p/576p/576i/480p/480i Video input (Composite, S-Video): NTSC/PAL/SECAM/NTSC4.43/PAL-M/PAL-N/PAL-60 DMI: Digital PC / Digital video/MHL input Mini D-sub 15: Analog PC/Component video input Mini DIN4: S-video input Mini jack x2: Audio input x 1, Audio output x 1 Dsub9: RS-232 connection RJ-45: 100BASE-TX / 10BASE-T USB type B: Service port
Connection terminal	

* This indicates the overall average value of the product at the time of shipping, and it is listed in accordance with pattern for data projectors JIS X 6911:2003. The measurement method and measurement conditions are based on the Annex.

Cabinet	Molded plastic
External dimensions	<LV-WX320/LV-X320>Width 282mm Height 114.5mm (with legs at minimum height) Depth 267.5mm (including lens) <LV-WX310ST/LV-X310ST>Width 282mm Height 117.9mm (with legs at minimum height) Depth 267.5mm (including lens)
Weight	<LV-WX320/LV-X320>About 2.5kg<LV-WX310ST/LV-X310ST>About 2.8kg
Environmental conditions	Use environment: 0°C - 40°C
Supplied remote control	Power supply used: DC 3V Requires CR2025, Operation distance (for wireless): About 8m (receiver front ±30°)

* This is the average. It may vary for each product.

Accessories ●Power cord ... 1 ●Computer connection cable (Mini Dsub 15-pin) ... 1
●Wireless remote connector (LV-RC08) ... 1 ●CR2025 battery ... 1

Sold separately ●Wireless remote connector (LV-RC08)

Replacement products ●Replacement-use lamp [Recommended replacement time*; Standard 4000H/Quiet 6000H] (LV-LP40: LV-WX320/LV-WX310ST, LV-LP38: LV-X320/LV-X310ST)

* When the lamp has a 50% survival rate and can maintain a 50% light retention ratio.

External dimensions diagram

(Unit: mm)

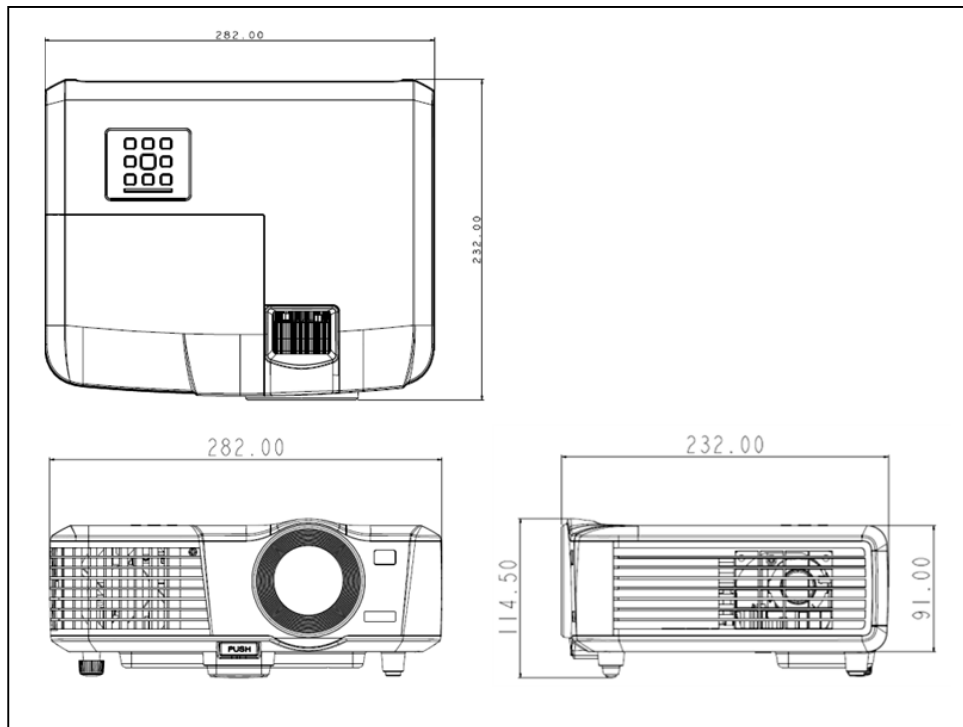

(Note) The above diagrams are not drawn to scale.

<Terminals>

(Unit: mm)

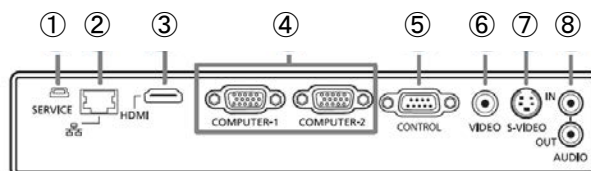

①	SERVICE (For service personnel)
②	LAN (RJ-45): Network connection (100BASE-TX / 10BASE-T)
③	HDMI/MHL input
④	PC input x2: Analog PC input/Component input
⑤	CONTROL: RS232C connection
⑥	VIDEO input
⑦	S-VIDEO input
⑧	AUDIO IN AUDIO OUT

■ Names

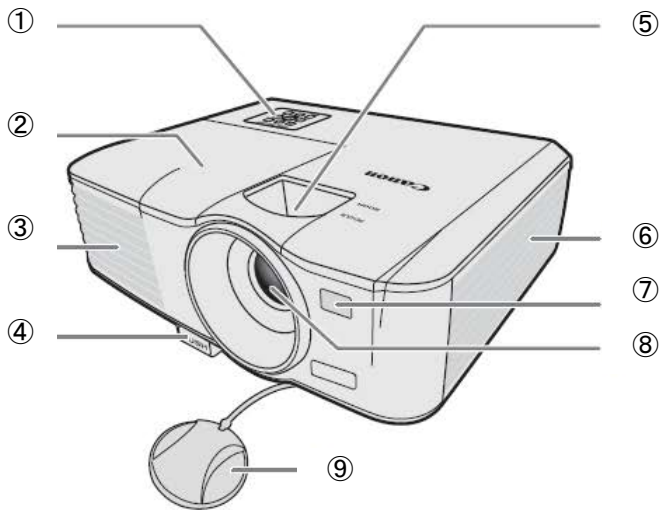

Connectors (refer to page 2)

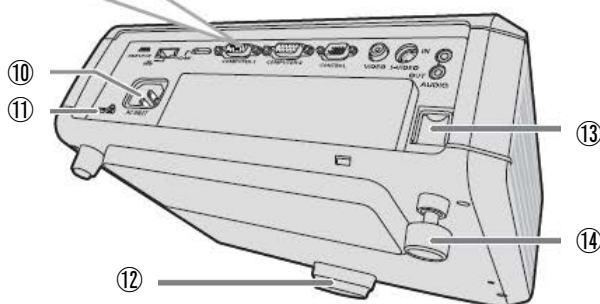

Top Controls

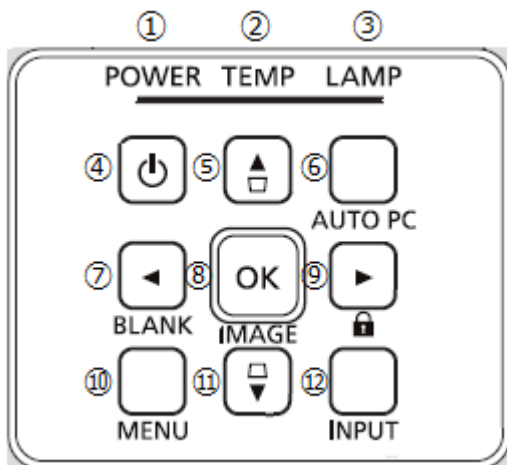

- ① Top controls and indicators
- ② Lamp cover
- ③ Exhaust vents
- ④ Angle adjusting button
- ⑤ Focus ring/Zoom ring
- ⑥ Front infrared remote receiver
- ⑦ Projection lens
- ⑧ Air intake vents
- ⑨ Lens cover
- ⑩ Power cord connector
- ⑪ Kensington security slot
- ⑫ Adjustable feet (front)
- ⑬ Security bar
- ⑭ Adjustable feet (rear)

Top Control buttons/indicators

- ① POWER indicator
- ② TEMP (temperature indicator)
- ③ LAMP indicator
- ④ POWER button
- ⑤ Keystone adjustment (top)
- ⑥ AUTO PC button
- ⑦ To LEFT/BLANK button
- ⑧ OK/IMAGE button
- ⑨ To RIGHT/KEY LOCK button
- ⑩ MENU button
- ⑪ Keystone adjustment (bottom)
- ⑫ INPUT button

■ Throw distance and image size

Image size can be adjusted manually within a zoom range of 1.1x using the zoom ring. The projector is equipped with a varifocal lens, so adjusting the zoom will also change the focus. When focus is adjusted, the image size will change slightly; thus, the user should adjust zoom and focus alternately in order to achieve the desired image size.

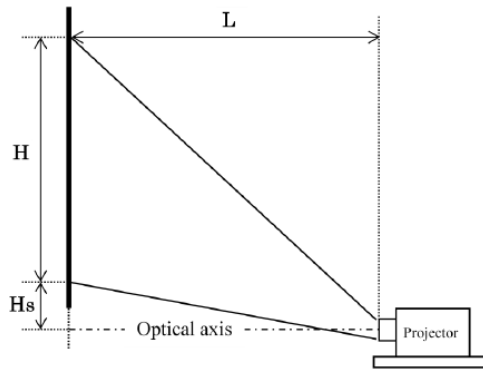

“L” in the diagram (left) represents throw distance. The same image size can be projected with the projector positioned anywhere between the shortest distance L(W) and the longest distance L(T). Here (W) indicates wide, and (T) stands for tele.

H is the vertical height of the image, and Hs indicates the distance between the optical axis of the lens and the bottom edge of the image.

For this projector the relationship between H and Hs is fixed:

LV-WX320 10:0 (Hs =H/0)

LV-X320 10:1 (Hs = 0)

LV-WX310ST 10:0.5 (Hs =H/20)

LV-X310ST 10:1.5 (Hs =H/20)

Image size and throw distance are as indicated below.

(Unit: m)

LV-WX320

Image size (16:10)			Projection distance	
Type	Width	Height	Wide lens	Tele lens
60	1.29	0.81	2.0	2.2
70	1.51	0.94	2.3	2.6
80	1.72	1.08	2.7	2.9
90	1.94	1.21	3.0	3.3
100	2.15	1.35	3.3	3.7
120	2.58	1.62	4.0	4.4
150	3.23	2.02	5.0	5.5
180	3.88	2.42	6.0	6.6

LV-X320

Image size (4:3)			Throw distance	
Type	Width	Height	Wide lens	Tele lens
60	1.22	0.91	2.4	2.6
70	1.42	1.07	2.8	3.1
80	1.63	1.22	3.2	3.5
90	1.83	1.37	3.6	3.9
100	2.03	1.52	4.0	4.4
120	2.44	1.83	4.8	5.2
150	3.05	2.29	6.0	6.6
180	3.66	2.74	7.2	7.9

LV-WX310ST

Image size (16:10)			Projection distance
Type	Width	Height	Wide lens
70	1.51	0.94	0.74
80	1.72	1.08	0.84
90	1.94	1.21	0.95
100	2.15	1.35	1.05
120	2.58	1.62	1.26

LV-X310ST

Image size (4:3)			Throw distance
Type	Width	Height	Wide lens
60	1.22	0.91	0.74
70	1.42	1.07	0.86
80	1.63	1.22	0.99
90	1.83	1.37	1.11
100	2.03	1.52	1.23
120	2.44	1.83	1.48

※Figures in the above chart are approximate.

■Adjustable feet

Diagram 1

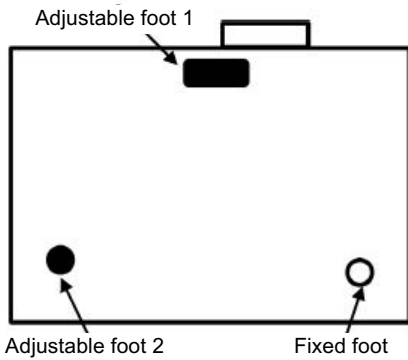
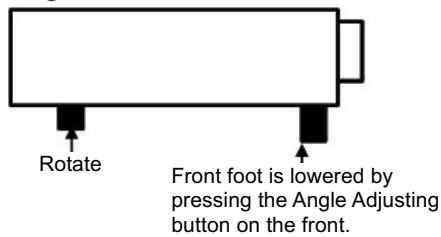

Diagram 1 shows the projector base, featuring two adjustable feet. Adjustable foot 1, located below the lens, is used to adjust the angle of the projector by raising or lowering the front. Adjustable foot 2 is used to adjust left/right tilt.

Diagram 2 is a side view of the projector. Pressing a release button located on the front of the projector will cause it to lower with its own weight. Adjustable foot 2 is a screw-type mechanism, which can be adjusted by rotating the foot.

The projection angle can be adjusted up to 6.0 degrees with adjustable foot 1.

Diagram 2



■ List of supported signals

The video signals that can be input in this product are described in the table below.

● Digital PC

Signal format	Horizontal frequency [KHz]	Refresh Rate [Hz]	Clock [MHz]
720x400	31.469	70.087	28.3221
640x480	31.469	59.940	25.175
	37.861	72.809	31.500
	37.500	75.000	31.500
	43.269	85.008	36.000
800x600	37.879	60.317	40.000
	48.077	72.188	50.000
	46.875	75.000	49.500
	53.674	85.061	56.250
1024x768	77.425	119.854	83.000
	48.363	60.004	65.000
	56.476	70.069	75.000
	60.023	75.029	78.750
1024x768	68.667	84.997	94.500
	97.551	119.989	115.500
	1152x864	67.500	75.000
1280x720	45.000	60	74.250
	90.000	120	148.500
1280x768	47.396	60	68.25
	47.776	59.870	79.5
1280x800	49.702	59.810	83.500
	62.795	74.934	106.500
	71.554	84.880	122.500
	101.563	119.909	146.25
1280x1024	63.981	60.020	108.000
	79.976	75.025	135.000
	91.146	85.024	157.500
1280x960	85.938	85.002	148.500
1360x768	47.712	60.015	85.500
1440x900	55.469	60	88.75
	55.935	59.887	106.500
1400x1050	65.317	59.978	121.750
1600x1200	75.000	60.000	162.000
1680x1050	64.674	59.883	119.000
	65.290	59.954	146.250
1366x768	47.712	59.790	85.500
1600x900	60.000	60.000	108.000

● Digital video

Signal format	Horizontal frequency [KHz]	Vertical frequency [Hz]	Dot clock frequency [MHz]
480i	59.94	15.73	27
480p	59.94	31.47	27
576i	50	15.63	27
576p	50	31.25	27
720p	50	37.5	74.25
	60	45.00	74.25
1080i	50	28.13	74.25
	60	33.75	74.25
1080P	24	27	74.25
	25	28.13	74.25
	30	33.75	74.25
	50	56.25	148.5
60	67.5	148.5	

● 4.25020c

Signal	Horizontal	Vertical	Dot clock
480i	15.73	59.94	27
480p	31.47	59.94	27
576i	15.63	50	27
576p	31.25	50	27
720/50p	37.5	50	74.25
720/60p	45	60	74.25
1080/24p	27	24	74.25
1080/25p	28.13	25	74.25
1080/30p	33.75	30	74.25
1080/50i	28.13	50	74.25
1080/60i	33.75	60	74.25
1080/50p	56.26	50	148.5
1080/60p	67.5	60	148.5

• Analog PC input

Signal format	Horizontal frequency [KHz]	Refresh Rate [Hz]	Clock [MHz]
720x400	31.469	70.087	28.3221
640x480	31.469	59.940	25.175
	37.861	72.809	31.500
	37.500	75.000	31.500
	43.269	85.008	36.000
800x600	37.879	60.317	40.000
	48.077	72.188	50.000
	46.875	75.000	49.500
	53.674	85.061	56.250
1024x768	77.425	119.854	83.000
	48.363	60.004	65.000
	56.476	70.069	75.000
	60.023	75.029	78.750
1152x864	68.667	84.997	94.500
	97.551	119.989	115.500
1280x864	67.500	75.000	108.000
1280x720	45.000	60	74.250
	90.000	120	148.500
1280x768	47.396	60	68.25
	47.776	59.870	79.5
1280x800	49.702	59.810	83.500
	62.795	74.934	106.500
	71.554	84.880	122.500
	101.563	119.909	146.25
1280x1024	63.981	60.020	108.000
	79.976	75.025	135.000
	91.146	85.024	157.500
1280x960	85.938	85.002	148.500
1360x768	47.712	60.015	85.500
1440x900	55.469	60	88.75
	55.935	59.887	106.500
1400x1050	65.317	59.978	121.750
1600x1200	75.000	60.000	162.000
1680x1050	64.674	59.883	119.000
	65.290	59.954	146.250
1366x768	47.712	59.790	85.500
1600x900	60.000	60.000	108.000

• Component video input

Signal format	Horizontal frequency [KHz]	Vertical frequency [Hz]	Dot clock frequency [MHz]
480i	59.940	15.734	13.500
480p	59.940	31.469	27.000
576i	50.000	15.625	13.500
576p	50.000	31.250	27.000
720/50p 720/60p	50.000	37.500	74.250
	60.000	45.000	74.250
1080/50i 1080/60i	50.000	28.125	74.250
	60.000	33.750	74.250
1080/50p 1080/60p	50.000	56.250	148.500
	60.000	67.500	148.500

• S-video/video input

Signal format	Horizontal frequency [KHz]	Vertical frequency [Hz]	Sub-Carrier frequency [MHz]
NTSC	60	15.73	3.58
PAL	50	15.63	4.43
SECAM	50	15.63	4.25 or 4.41
PAL-M	60	15.73	3.58
PAL-N	50	15.63	3.58
PAL-60	60	15.73	4.43
NTSC4.43	60	15.73	4.43

■ Accessories

Supplied	Projector Remote Controller LV-RC08	Power source: DC 3.0V (uses CR2025 battery) Operating range: Distance of approx. 8 m from the projector; angle of $\pm 30^\circ$ in any direction from directly in front of the infrared remote receiver.
	Computer Cable	Mini Dsub15-MiniDsub15 Used to connect the projector to a PC for transferring analog PC signals.
Options	Projector Remote Controller LV-RC08	Same as the supplied accessory.
Replacement Parts	Replacement Lamp LV-LP38	Ultra high-pressure mercury lamp for the LV-X320/X310ST model Recommended replacement time* ¹ : 4000H/6000H (Lamp mode: Normal/Eco)
	Replacement Lamp LV-LP40	Ultra high-pressure mercury lamp for the LV-WX320/WX310ST model Recommended replacement time* ¹ : 4000H/6000H (Lamp mode: Normal/Eco)

*1: When the lamp has a 50% survival rate and can maintain a 50% light retention ratio.

■ Precautions when installing/using

High wattage lamps are used in the projector, and it becomes very hot. Take care as follows.

- (1) This projector produces intense light from the projection lens. Do not stare directly into the lens, otherwise damage to eyes could result.
- (2) Do not set anything on top of the projector. Also do not project with projectors stacked directly on top of each other.
- (3) Do not place any object in front of the lens while the projector is in use as focused light projected to an object for a prolonged time may result in a fire.
- (4) Do not block the intake and exhaust vents of the projector.
Also, install the projector so that the intake and exhaust vents are not subjected directly to warm air and cold air of air conditioning.
- (5) The projector uses high-pressure mercury lamp for its light source, which may deteriorate or reduce luminance owing to the characteristics and extensive use of the mercury lamp. Prolonged usage may also lead to breakage of the lamp. In such instances, immediately replace the lamp to a new lamp. Contact a local dealer for service and replacement of the lamp; such maintenance should be conducted at a service center by a qualified personnel.
- (6) When operating the projector inserted in a box, ensure that the ambient temperature within the box during operation is within the range of 0°C to 40°C. Also, do not block the intake and exhaust vents. Even when the ambient temperature is 40°C or lower, the protection circuit of the projector may function and shut down the projector due to internal retention of the exhaust heat. Sufficiently consider the ambient temperature environment when installing the projector.
- (7) Set the Fan Control mode (High altitude mode) to ON when using the projector in high altitudes (1,500 meters or more above sea level) where the atmospheric pressure is low.